

12 X Zoom High Mag Zoom Lenses



- Incredible 12:1 Zoom ratio with dynamic magnification range of 0.07X-583X.
- Telecentric attachment gives you the world's first parfocal telecentric zoom lens with field coverage up to 50 mm.
- Increased resolution with 0.018-0.1 N.A.
- Variable working distance from 32 to 341 mm.
- Field of view from 0.006 mm to 85.71 mm with attachments.
- Unmatched edge flatness and clarity.
- Works with 1/4", 1/3", 1/2" and 2/3" format cameras.
- The 12X Zoom System is compatible with Zoom 6000 adapter tubes.

12X Zoom



12X Zoom High Mag Zoom Lenses

Raising the Standard for Optical Excellence

The Highest Combination of Zoom Range and Resolution in a State-of-the-Art Optical System

Navitar's 12X Zoom is the next generation in video zoom optics. With a zoom ratio of 12:1, a zoom range of 0.58X to 7X and a dynamic magnification range of .07 to 583X, the 12X is the only single lens system to provide such a high combination of zoom range and resolution. This outstanding combination of video clarity and zoom range, coupled with unprecedented field coverage, means that you will now be able to view a wider range of parts with a single video inspection system.

Flexible by Design

The 12X Zoom system is designed on a modular basis, offering optical quality and mechanical flexibility. This interchangeable design, combined with a wide range of lens adapters and attachments, allows you to easily choose the magnification, field of view and working distance that best suit your viewing needs. In fact, the 12X Zoom system is even compatible with existing Zoom 6000 adapters.

All 12X Zoom models have a 12X parfocal zoom lens system with a high N.A. (0.018 - 0.1) to achieve higher resolution and

improved contrast. Working distance can be varied from 32 mm (1.25") to 341 mm (13.4") and fields of view can be achieved from 0.006 mm to 85.71 mm.

Designed to Increase Productivity

The 12X Zoom system is ideal for use in the inspection of a wide range of products, such as semiconductor chips, PC boards and life science applications. It increases productivity by eliminating the need to change components to view a wider range of parts. It's easy to use and displays crisp, clear images on any monitor for individual or group viewing.



Unbeatable Accuracy

Our 12X Zoom delivers unbeatable accuracy and repeatability for even the toughest die bonding, life science, and FPD inspection applications. Superb Navitar optics deliver remarkably high contrast, high resolution video images. The 12:1 zoom ratio provides an incredible magnification range that allows both high magnification for precision measurement and inspection, as well as low magnification for a wider field of view. Bonding, probing, scribing and aligning applications can all be performed better and more accurately than with any other zoom lens on the market.

Key Terms for Matrix Charts

Depth of Field

The distance allowing acceptable image definition to be maintained without refocusing.

Distortion

Distortion is a variation in magnification across the field of view.

Field

Field of view for respective camera format (normally measured diagonally).

Magnification

A measure of the apparent differences in size between the object and image.

Matching Pixel Size

Matching pixel size is that which will permit the minimum feature size to overlap two pixels.

MTF (lp/mm)

A measurement of the ability of an optical system to reproduce (transfer) various levels of detail from the object to the image, as shown by the degree of contrast (modulation) in the image.

N.A. Image (high or low mag.)

Measurement at the image point of the largest cone of light rays that are exiting the optical system.

N.A. Object (high or low mag.)

Measurement at the object point of the largest cone or number of light rays that are entering the optical system.

Object to Image Distance (O-I)

Total distance from the object to the sensor inside the camera.

Resolvable Features (microns)

Measurement of lens system's ability to image closely spaced points, lines and object surfaces as separate entities.

Working Distance (W.D.)

Clearance between object and lowest mechanical part of the system.

12X Zoom System Diagram

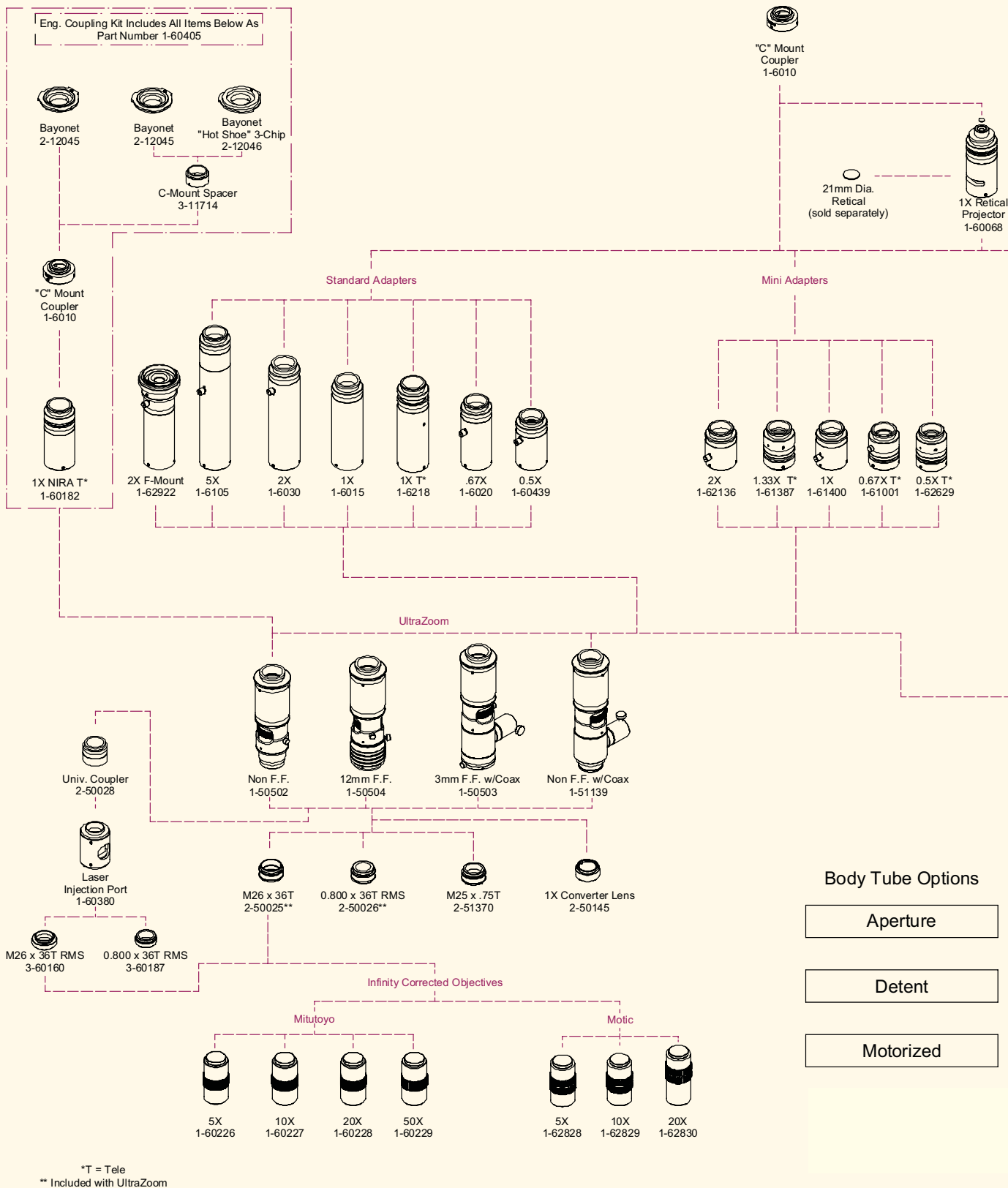

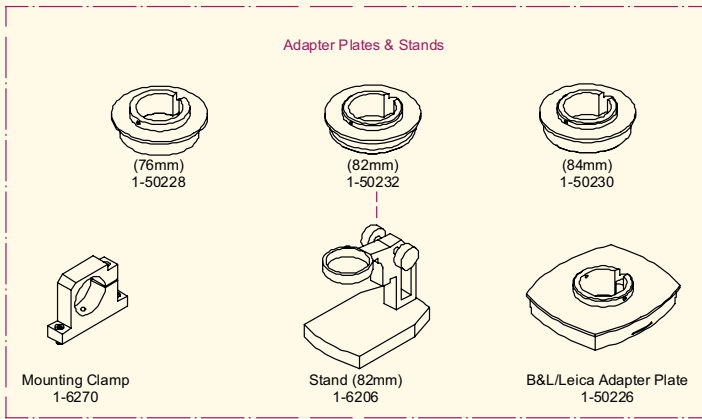
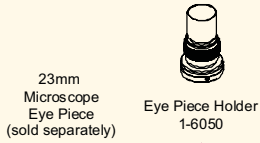

Short Adapters

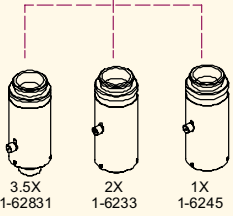

Non-Inv. Right Angle Adapters

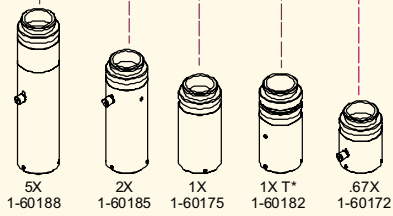

Right Angle Adapters

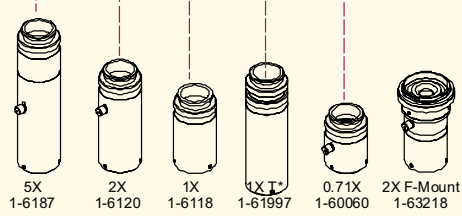

Zoom Lenses

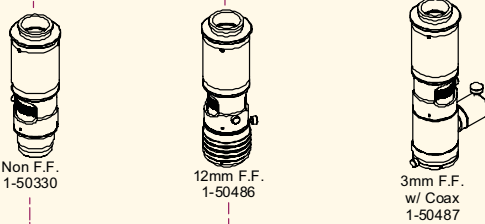

Telecentric Zoom Lenses

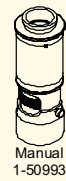

Lens Attachments

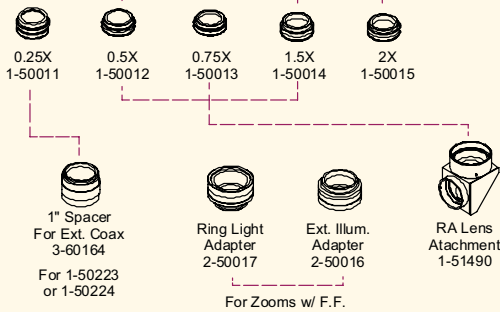

Telecentric Attachments

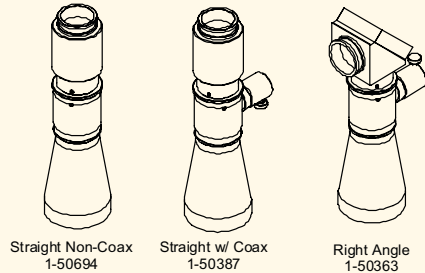

Rev.031708



12X Zoom system dimensions can be found on our website at www.machinevision.navitar.com.

12X Zoom

12X Zoom Field of View Matrix (in mm)

Lens Attachment	Working Distance	Camera Formats/ Parameters	0.5X Adapter Low - High	0.67X Adapter Low - High	1X Adapter Low - High	1.33X Adapter Low - High	2X Adapter Low - High	3.5 Adapter Low - High	Resolve Limit (microns) Low - High	Depth of Field (mm) Low - High
0.25X (2)0.005 - 0.025 N.A. 1-50011	341	Mag.	0.07X - 0.87X	0.10X - 1.20X	0.15X - 1.75X	0.19X - 2.33X	0.29X - 3.50X	0.51X - 6.13X	33.33 - 6.67	20.00 - 0.80
		Field 1/4"	57.14 - 4.59	41.16 - 3.40	27.60 - 2.28	21.05 - 1.72	13.79 - 1.14	7.84 - 0.65	33.33 - 6.67	20.00 - 0.80
		Field 1/3"	85.71 - 6.89	61.73 - 5.10	41.38 - 3.42	31.57 - 2.57	20.69 - 1.71	11.76 - 1.79	33.33 - 6.67	20.00 - 0.80
		Field 1/2"	—	82.32 - 6.80	55.16 - 4.56	42.10 - 3.43	27.58 - 2.28	15.68 - 1.30	33.33 - 6.67	20.00 - 0.80
		Field 2/3"	—	(1) 72.00 - 9.35	75.88 - 6.28	57.89 - 4.72	37.94 - 3.14	21.56 - 1.79	33.33 - 6.67	20.00 - 0.80
0.5X 0.009 - 0.051 N.A. 1-50012	165	Mag.	0.14X - 1.75X	0.20X - 2.40X	0.29X - 3.50X	0.39X - 4.66X	0.58X - 7.00X	1.02X - 12.3X	18.52 - 3.33	6.17 - 0.19
		Field 1/4"	28.57 - 2.28	20.58 - 1.70	13.79 - 1.14	10.25 - 0.86	6.90 - 0.76	3.92 - 0.32	18.52 - 3.33	6.17 - 0.19
		Field 1/3"	42.85 - 3.42	30.87 - 2.55	20.69 - 1.71	15.38 - 1.29	10.34 - 0.86	5.88 - 0.48	18.52 - 3.33	6.17 - 0.19
		Field 1/2"	—	41.16 - 3.40	27.58 - 2.28	20.51 - 1.72	13.79 - 1.14	7.84 - 0.65	18.52 - 3.33	6.17 - 0.19
		Field 2/3"	—	(1) 36.0 - 4.68	37.94 - 3.14	28.20 - 2.36	18.97 - 1.57	10.78 - 0.89	18.52 - 3.33	6.17 - 0.19
0.75X 0.014 - 0.076 N.A. 1-50013	108	Mag.	0.22X - 2.62X	0.29X - 3.50X	0.44X - 5.30X	0.58X - 6.98X	0.87X - 10.50X	1.53X - 18.4X	11.90 - 2.22	2.55 - 0.09
		Field 1/4"	18.18 - 1.52	13.72 - 1.14	9.19 - 0.76	6.89 - 0.57	4.60 - 0.38	2.61 - 0.22	11.90 - 2.22	2.55 - 0.09
		Field 1/3"	27.27 - 2.29	20.58 - 1.70	13.79 - 1.14	10.34 - 0.85	6.89 - 0.57	3.92 - 0.32	11.90 - 2.22	2.55 - 0.09
		Field 1/2"	—	27.44 - 2.27	18.34 - 1.52	13.79 - 1.14	9.19 - 0.76	5.22 - 0.43	11.90 - 2.22	2.55 - 0.09
		Field 2/3"	—	(1) 24.30 - 3.12	25.30 - 2.09	18.96 - 1.57	12.64 - 1.05	7.18 - 0.59	11.90 - 2.22	2.55 - 0.09
None 0.019 - 0.101 N.A.	86	Mag.	0.29X - 3.49X	0.39X - 4.70X	0.58X - 7.00X	0.77X - 9.31X	1.16X - 14.00X	2.03X - 24.5X	9.26 - 1.67	1.39 - 0.05
		Field 1/4"	13.79 - 1.14	10.29 - 0.85	6.90 - 0.57	5.19 - 0.43	3.45 - 0.29	1.97 - 0.16	9.26 - 1.67	1.39 - 0.05
		Field 1/3"	20.69 - 1.72	15.44 - 1.28	10.34 - 0.86	7.79 - 0.64	5.18 - 0.43	2.95 - 0.24	9.26 - 1.67	1.39 - 0.05
		Field 1/2"	—	20.58 - 1.70	13.79 - 1.14	10.39 - 0.86	6.90 - 0.57	3.94 - 0.32	9.26 - 1.67	1.39 - 0.05
		Field 2/3"	—	(1) 18.20 - 2.34	18.97 - 1.57	14.28 - 1.18	9.49 - 0.78	5.42 - 0.44	9.26 - 1.67	1.39 - 0.05
1.5X 0.028 - 0.151 N.A. 1-50014	50	Mag.	0.43X - 5.23X	0.58X - 7.00X	0.87X - 10.50X	1.16X - 14.0X	1.74X - 21.00X	3.05X - 36.8X	6.17 - 1.12	0.64 - 0.02
		Field 1/4"	9.30 - 0.76	6.86 - 0.57	4.60 - 0.38	3.44 - 0.28	2.30 - 0.19	1.31 - 0.11	6.17 - 1.12	0.64 - 0.02
		Field 1/3"	13.95 - 1.14	10.29 - 0.85	6.89 - 0.57	5.17 - 0.44	3.45 - 0.29	1.96 - 0.16	6.17 - 1.12	0.64 - 0.02
		Field 1/2"	—	13.72 - 1.13	9.19 - 0.76	6.89 - 0.57	4.60 - 0.38	2.62 - 0.22	6.17 - 1.12	0.64 - 0.02
		Field 2/3"	—	(1) 12.20 - 1.55	12.64 - 1.05	9.48 - 0.78	6.33 - 0.52	3.60 - 0.23	6.17 - 1.12	0.64 - 0.02
2.0X 0.038 - 0.202 N.A. 1-51473	32	Mag.	0.58X - 6.98X	0.78X - 9.40X	1.16X - 14.00X	1.54X - 18.6X	2.32X - 28.00X	4.06X - 49.0X	4.50 - 0.83	0.35 - 0.01
		Field 1/4"	6.89 - 0.57	5.14 - 0.43	3.45 - 0.29	2.59 - 0.21	1.73 - 0.15	0.98 - 0.08	4.50 - 0.83	0.35 - 0.01
		Field 1/3"	10.34 - 0.85	7.72 - 0.64	5.18 - 0.43	3.89 - 0.32	2.59 - 0.22	1.47 - 0.12	4.50 - 0.83	0.35 - 0.01
		Field 1/2"	—	10.29 - 0.85	6.90 - 0.57	5.19 - 0.43	3.45 - 0.29	1.97 - 0.16	4.50 - 0.83	0.35 - 0.01
		Field 2/3"	—	(1) 9.10 - 1.17	9.49 - 0.78	7.14 - 0.59	4.75 - 0.40	2.71 - 0.22	4.50 - 0.83	0.35 - 0.01

(1) Vignetting occurs at zoom settings less than 0.9X.
 (2) N.A. varies depending on zoom setting.

12X Zoom System Dimensions

*All measurements are in mm unless otherwise specified.

Navitar offers a wide variety of lenses, adapters and attachments. Dimensions of a few examples are provided here. For a complete listing of lens dimensions, please visit www.machinevision.navitar.com.

Lenses*

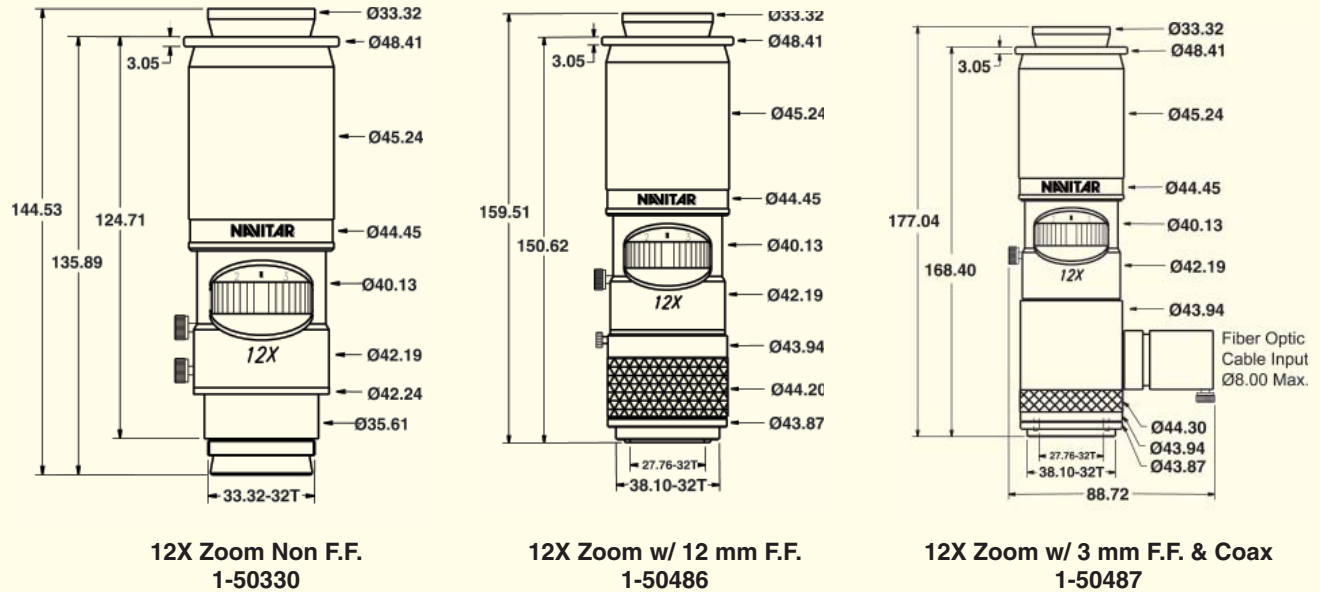

Adapters*

All adapters have a diameter of $\varnothing 40.64$ mm ($\varnothing 1.600$ inches)

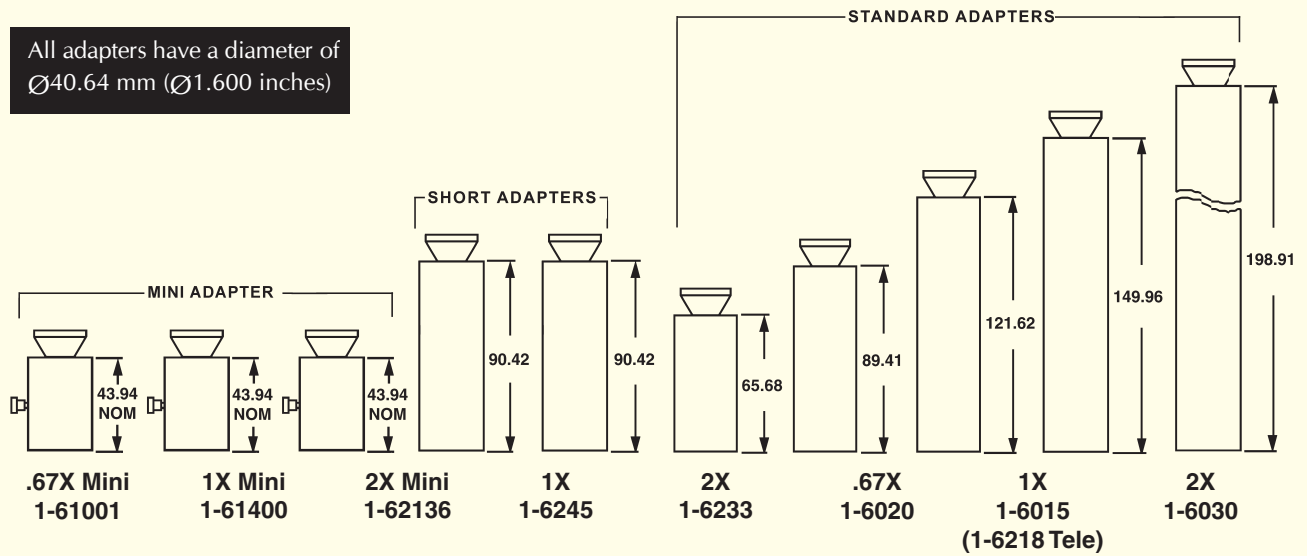

Attachments*

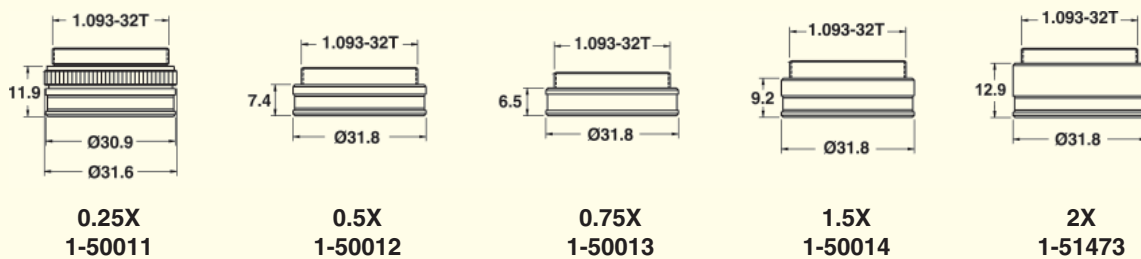



12X Zoom Performance Specifications

12X Zoom Combinations Lens Attach. + Prime Lens + Adapter	W.D.	System Mag.		N.A. -obj-		Resolve Limit micron		Matching Pixel Size microns		Depth of Field	
		Low Mag.	High Mag.	Low Mag.	High Mag.	Low Mag.	High Mag.	Low Mag.	High Mag.	Low Mag.	High Mag.
0.25x + 12X Zoom + 0.5x	341	0.07	0.87	0.005	0.025	33.33	6.67	2.33	5.8	20.00	0.80
0.25x + 12X Zoom + 0.67x	341	0.10	1.17	0.005	0.025	33.33	6.67	3.33	7.80	20.00	0.80
0.25x + 12X Zoom + 1.0x	341	0.15	1.75	0.005	0.025	33.33	6.67	5.00	11.67	20.00	0.80
0.25x + 12X Zoom + 1.33x	341	0.19	2.33	0.005	0.025	33.33	6.67	6.33	15.54	20.00	0.80
0.25x + 12X Zoom + 2.0x	341	0.29	3.50	0.005	0.025	33.33	6.67	9.67	23.34	20.00	0.80
0.25x + 12X Zoom + 3.5x	341	0.51	6.13	0.005	0.025	33.33	6.67	16.99	40.88	20.00	0.80
0.5x + 12X Zoom + 0.5x	165	0.14	1.75	0.009	0.051	18.52	3.33	2.59	5.82	6.17	0.19
0.5x + 12X Zoom + 0.67x	165	0.19	2.35	0.009	0.051	18.52	3.33	3.60	7.68	6.17	0.19
0.5x + 12X Zoom + 1.0x	165	0.29	3.50	0.009	0.051	18.52	3.33	5.38	11.45	6.17	0.19
0.5x + 12X Zoom + 1.33x	165	0.39	4.66	0.009	0.051	18.52	3.33	7.22	15.51	6.17	0.19
0.5x + 12X Zoom + 2.0x	165	0.58	7.00	0.009	0.051	18.52	3.33	10.74	22.89	6.17	0.19
0.5x + 12X Zoom + 3.5x	165	1.02	12.30	0.009	0.051	18.52	3.33	18.89	40.95	6.17	0.19
0.75x + 12X Zoom + 0.5x	108	0.22	2.62	0.014	0.076	11.90	2.22	2.61	5.81	2.55	0.09
0.75x + 12X Zoom + 0.67x	108	0.29	3.52	0.014	0.076	11.90	2.22	3.45	7.73	2.55	0.09
0.75x + 12X Zoom + 1.0x	108	0.44	5.25	0.014	0.076	11.90	2.22	5.24	11.52	2.55	0.09
0.75x + 12X Zoom + 1.33x	108	0.58	6.98	0.014	0.076	11.90	2.22	6.90	15.49	2.55	0.09
0.75x + 12X Zoom + 2.0x	108	0.87	10.50	0.014	0.076	11.90	2.22	10.35	23.05	2.55	0.09
0.75x + 12X Zoom + 3.5x	108	1.53	18.40	0.014	0.076	11.90	2.22	18.20	40.84	2.55	0.09
None + 12X Zoom + 0.5x	86	0.29	3.49	0.019	0.101	9.26	1.67	2.68	5.82	1.39	0.05
None + 12X Zoom + 0.67x	86	0.39	4.69	0.019	0.101	9.26	1.67	3.42	7.74	1.39	0.05
None + 12X Zoom + 1.0x	86	0.58	7.00	0.019	0.101	9.26	1.67	5.09	11.55	1.39	0.05
None + 12X Zoom + 1.33x	86	0.77	9.31	0.019	0.101	9.26	1.67	7.13	15.54	1.39	0.05
None + 12X Zoom + 2.0x	86	1.16	14.00	0.019	0.101	9.26	1.67	10.17	23.10	1.39	0.05
None + 12X Zoom + 3.5x	86	2.03	24.50	0.019	0.101	9.26	1.67	18.79	40.91	1.39	0.05
1.5x + 12X Zoom + 0.5x	50	0.43	5.23	0.028	0.151	6.17	1.12	2.65	5.85	0.64	0.02
1.5x + 12X Zoom + 0.67x	50	0.58	7.04	0.028	0.151	6.17	1.12	3.45	7.78	0.64	0.02
1.5x + 12X Zoom + 1.0x	50	0.87	10.50	0.028	0.151	6.17	1.12	5.18	11.60	0.64	0.02
1.5x + 12X Zoom + 1.33x	50	1.16	14.00	0.028	0.151	6.17	1.12	7.15	15.68	0.64	0.02
1.5x + 12X Zoom + 2.0x	50	1.74	21.00	0.028	0.151	6.17	1.12	10.74	23.34	0.64	0.02
1.5x + 12X Zoom + 3.5x	50	3.05	36.80	0.028	0.151	6.17	1.12	18.81	41.21	0.64	0.02
2.0x + 12X Zoom + 0.5x	32	0.58	6.98	0.038	0.202	4.50	0.83	2.61	5.79	0.35	0.01
2.0x + 12X Zoom + 0.67x	32	0.78	9.38	0.038	0.202	4.50	0.83	3.42	7.79	0.35	0.01
2.0x + 12X Zoom + 1.0x	32	1.16	14.00	0.038	0.202	4.50	0.83	5.09	11.62	0.35	0.01
2.0x + 12X Zoom + 1.33x	32	1.54	18.60	0.038	0.202	4.50	0.83	6.93	15.43	0.35	0.01
2.0x + 12X Zoom + 2.0x	32	2.32	28.00	0.038	0.202	4.50	0.83	10.17	23.24	0.35	0.01
2.0x + 12X Zoom + 3.5x	32	4.06	49.00	0.038	0.202	4.50	0.83	18.27	40.67	0.35	0.01

Assumptions:

1. Minimum resolvable feature size is half of the threshold line pair limit. Calculation = $1/(3000 \times \text{Lens N.A.})$
2. Matching pixel size is that which will permit the minimum feature size to overlap two pixels. Calculation = $1/2(\text{Feature Size} \times \text{System Magnification})$
3. If the matching pixel size is greater than the camera pixel size, the system is "lens limited."
4. If the matching pixel size is less than the camera pixel size, the system is "camera limited."

12X Zoom Distortion %

This data is plus-minus calibrated distortion based on best-fit mag.

Mag	% Distortion
0.580	0.109
0.600	0.107
0.650	0.100
0.700	0.089
0.800	0.077
0.900	0.068
1.000	0.060
1.250	0.048
1.500	0.042
1.750	0.039
2.000	0.038
2.250	0.037
2.500	0.037
2.750	0.038
3.000	0.039
3.250	0.041
3.500	0.042
3.750	0.044
4.000	0.037
4.499	0.040
4.999	0.044
5.499	0.047
5.998	0.051
6.497	0.057
6.995	0.062

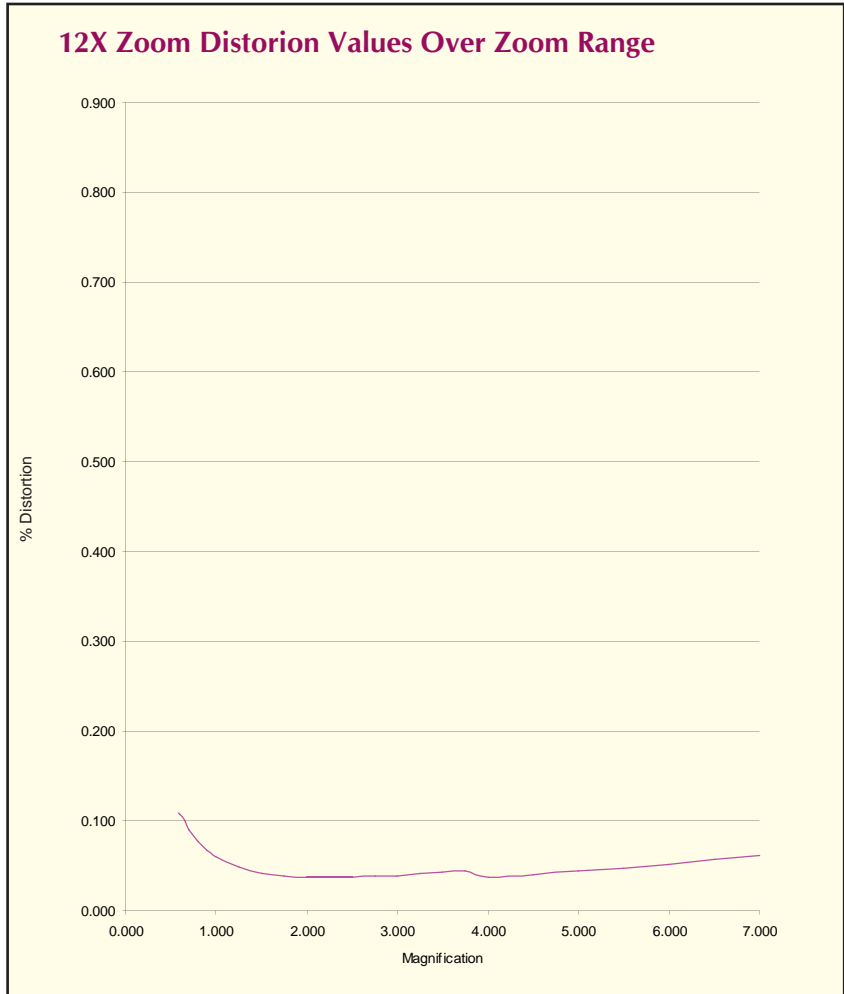



12X Internal Co-axial Zoom

Navitar's 12X Zoom with Internal Co-axial Illumination (1-50487) is ideal for applications involving highly reflective surfaces, such as wafers, polished samples, and fluids. Designed to provide even illumination for higher magnification applications, it provides extremely detailed resolution under incident lighting, particularly when a high resolution camera is used. Various illumination sources can be used. For more information on LED or fiber optic illumination, see the Lighting Accessories section.

12X Zoom Field of View Matrix for Internal Co-axial Zoom - 1-50487 (mm)

Lens Attachment	W. D.	Camera Formats/Parameters	.67X Adapter Low - High	1X Adapter Low - High	1.33X Adapter Low - High	2X Adapter Low - High	3.5X Adapter Low - High
None 0.019 - 0.101 N.A.	86	Mag.	0.39X - 4.70X	0.58X - 7.00X	0.77X - 9.31X	1.16X - 14.00X	2.03X - 24.50X
		Field 1/4"	10.29 - 0.85	6.90 - 0.57	5.19 - 0.43	3.45 - 0.29	1.97 - 0.16
		Field 1/3"	15.44 - 1.28	10.34 - 0.86	7.80 - 0.64	5.18 - 0.43	2.95 - 0.24
		Field 1/2"	20.58 - 1.70	13.79 - 1.14	10.39 - 0.86	6.90 - 0.57	3.94 - 0.32
		Field 2/3"	(1) 16.38 - 2.34	18.97 - 1.57	14.28 - 1.18	9.49 - 0.78	5.41 - 0.45
1.5X 0.028 - 0.151 N.A. 1-50014	50	Mag.	0.58X - 7.00X	0.87 - 10.50X	1.16X - 14.00X	1.74X - 21.00X	3.05X - 36.80X
		Field 1/4"	6.86 - 0.57	4.60 - 0.38	3.45 - 0.29	2.30 - 0.19	1.31 - 0.11
		Field 1/3"	10.29 - 0.85	6.89 - 0.57	5.17 - 0.43	3.45 - 0.29	1.96 - 0.16
		Field 1/2"	13.72 - 1.13	9.19 - 0.76	6.89 - 0.57	4.60 - 0.38	2.62 - 0.22
		Field 2/3"	(1) 10.92 - 1.55	12.64 - 1.05	9.48 - 0.79	6.33 - 0.52	3.61 - 0.30
2.0X 0.038 - 0.202 N.A. 1-50015	32	Mag.	0.78X - 9.40X	1.16X - 14.00X	1.54X - 18.6X	2.32X - 28.00X	4.06X - 49.00X
		Field 1/4"	5.14 - 0.43	3.45 - 0.29	2.59 - 0.22	1.73 - 0.15	0.98 - 0.08
		Field 1/3"	7.72 - 0.64	5.18 - 0.43	3.89 - 0.32	2.59 - 0.22	1.47 - 0.12
		Field 1/2"	10.29 - 0.85	6.90 - 0.57	5.19 - 0.43	3.45 - 0.29	1.97 - 0.16
		Field 2/3"	(1) 8.19 - 1.17	9.49 - 0.78	7.14 - 0.59	4.75 - 0.40	2.71 - 0.22

Notes:

The internal coax will illuminate a circular area of about 14 mm in diameter. Any field of view larger than 14 mm will have darkened corners.

Low power lens attachments can be used but produce increasing vignetting.

(1) Zoom Setting at 1.0=X.

(2) N.A. varies depending on zoom setting



12X UltraZoom

Combine Infinity-Corrected Objectives for Maximum Resolution and Magnification

The 12X UltraZoom (1-50502) is a high performance system ideal for semiconductor inspection, flow cytometry, or other high magnification applications. Its advanced design offers high resolution and outstanding contrast. This system incorporates infinity corrected objectives to provide long working distances and excellent edge flatness and clarity. The system's resolution exceeds 1,650 lines per mm, depending on the objective used. The UltraZoom is also available with fine focus (1-50504) or with fine focus and co-axial illumination (1-50503).

12X UltraZoom Field of View Matrix for 1-50502, 1-50503 and 1-50504 (mm)

Objective Lens (Mitutoyo) Long W.D.	W.D. (mm)	Camera Formats/ Parameters	1X Adapter Low - High	1.33X Adapter Low - High	2X Adapter Low - High	3.5X Adapter Low - High
5X 0.14 NA* 1-60226	34	Mag.	(1) 3.57X - 16.66X	3.26X - 22.16X	2.77X - 33.31X	4.80X - 58.30X
		Field 1/4"	1.12 - 0.24	1.22 - 0.18	1.44 - 0.12	0.83 - 0.07
		Field 1/3"	1.68 - 0.36	1.84 - 0.27	2.17 - 0.18	1.25 - 0.10
		Field 1/2"	2.24 - 0.48	2.45 - 0.36	2.89 - 0.24	1.66 - 0.14
		Field 2/3"	—	2.45 - 0.49	3.97 - 0.33	2.29 - 0.19
10X 0.28 NA* 1-60227	33	Mag.	(1) 7.14X - 33.31X	6.50X - 44.30X	5.54X - 66.63X	9.70X - 116.60X
		Field 1/4"	0.56 - 0.12	0.61 - 0.09	0.72 - 0.06	0.41 - 0.03
		Field 1/3"	0.84 - 0.18	0.92 - 0.13	1.08 - 0.09	0.62 - 0.05
		Field 1/2"	1.12 - 0.24	1.23 - 0.18	1.44 - 0.12	0.82 - 0.07
		Field 2/3"	—	1.23 - 0.25	1.99 - 0.17	1.13 - 0.09
20X 0.42 NA* 1-60228	20	Mag.	(1) 14.28X - 64.63X	13.10X - 85.96X	11.08X - 133.25X	19.40X - 233.20X
		Field 1/4"	0.28 - 0.06	0.30 - 0.04	0.36 - 0.03	0.21 - 0.02
		Field 1/3"	0.42 - 0.09	0.46 - 0.07	0.54 - 0.04	0.31 - 0.03
		Field 1/2"	0.56 - 0.12	0.61 - 0.09	0.72 - 0.06	0.41 - 0.03
		Field 2/3"	—	0.61 - 0.13	0.99 - 0.08	0.57 - 0.05
50X 0.55 NA* 1-60229	13	Mag.	(1) 35.69X - 166.57X	40.00X - 221.54X	27.50X - 333.13X	48.10X - 583.00X
		Field 1/4"	0.11 - 0.02	0.10 - 0.02	0.14 - 0.01	0.08 - .006
		Field 1/3"	0.17 - 0.04	0.15 - 0.05	0.22 - 0.02	0.12 - 0.01
		Field 1/2"	0.22 - 0.05	0.20 - 0.04	(2) 0.17 - 0.03	0.16 - 0.01
		Field 2/3"	—	0.20 - 0.05	0.40 - 0.03	0.23 - 0.02

Note: This system is not recommended for use with a 2/3" CCD.

(1) Zoom setting at 1.5X.

(2) Zoom setting at 1.0X.

*N.A. at full zoom. N.A. varies with zoom setting.

12X Telecentric



The World's First Parfocal Telecentric Zoom Lens

The 12X Telecentric Zoom system allows users to reach a true telecentric condition to within less than 0.3° while maintaining constant perspective and magnification. This means that even if the object is slightly out of focus, the size of the image will not change. The 12X Telecentric Zoom provides field coverage from 50 mm down to 4 mm and the coaxial illumination allows clear viewing, even when working with mirror-like surfaces.

Wide Magnification Range and Ultra Long Working Distance

In the past, a telecentric lens was defined as having fixed magnification. Not anymore! The Navitar 12X Telecentric Zoom lens allows you to zoom in and focus over a wide

variety of magnifications with a higher level of accuracy than you ever thought possible. The 12X Telecentric provides adjustable focal lengths over a 0.16X to 1.94X magnification range. You no longer have to be limited by telecentric lenses that only offer fixed magnification. Now you have field coverage from 50 mm down to 4 mm at a 188 mm working distance.

No Need to Change Lenses

The easily adjustable field of view and magnification allow our Navitar 12X Telecentric lens to adjust to meet your exact requirements. It's no longer necessary to change lenses, mix and match base lenses with attachment lenses or recalibrate. One lens, the 12X Telecentric, really does it all!

Wide Range of Applications

Specifically designed for precise dimensional measurement of objects or pattern recognition, the 12X Telecentric Zoom has many applications. It's ideal for measuring three-dimensional objects with deep features, such as well plates, electrical connector pins, and other precision parts. It's also the perfect lens for viewing inconsistently placed parts on a conveyer belt.

12X Telecentric Accuracy

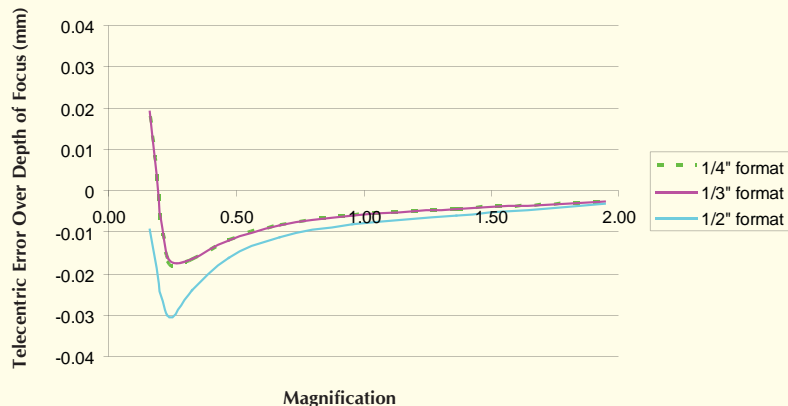

Telecentric Advantages Over Conventional Lenses

Constant Perspective for the Highest Degree of Accuracy

Navitar's 12X Telecentric lens is designed for "straight on" viewing of objects across the entire field of view. Images are not distorted and features are easy to examine. Conventional lenses view objects at different angles across the field of view. This changes the viewing perspective and can distort the size and shape of the object, making it difficult to view features accurately.

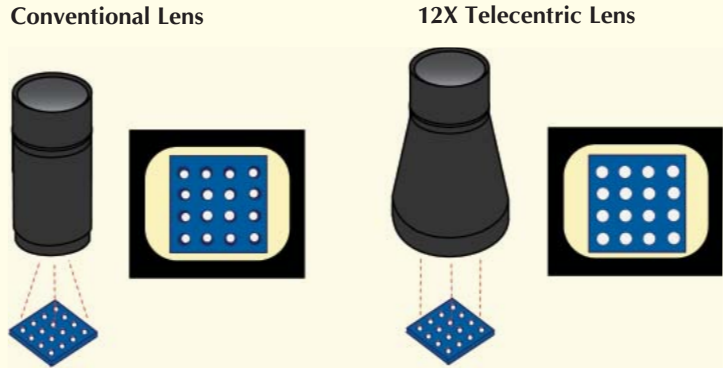

Constant Magnification Reduces Magnification Errors

Magnification in the Navitar 12X Telecentric, unlike conventional lenses, is independent of working distance. Magnification remains constant regardless of how close or far away an object is from the camera. This reduces magnification errors and greatly extends gauging depths of field. Conventional lenses, however, view objects that are closer to the camera as larger than objects that are farther away.

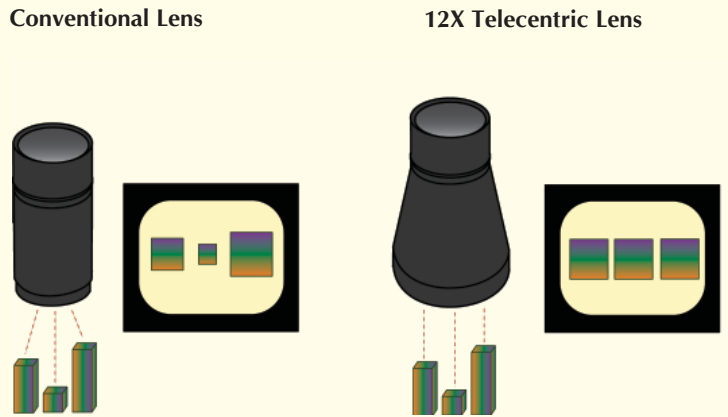

12X Telecentric Lens Specifications

Mag.	Telecentric Error (degrees)			Object N.A.	Image N.A.	Object Depth of Focus (mm)	Telecentric Error (mm)			Object Size			Approx. MTF (lp/mm)	Resolvable Features (microns)
	1/4"	1/3"	1/2"				1/4"	1/3"	1/2"	1/4"	1/3"	1/2"		
0.16	0.05	0.06	-0.03	0.005	0.032	38.8	0.018	0.020	-0.009	25.0	37.3	49.7	15	33
0.23	-0.10	-0.09	-0.18	0.007	0.031	19.4	-0.017	-0.016	-0.030	17.4	26.1	34.8	22	23
0.33	-0.19	-0.18	-0.27	0.010	0.030	10.3	-0.016	-0.016	-0.024	12.1	18.2	24.3	30	17
0.47	-0.23	-0.23	-0.31	0.013	0.028	6.0	-0.012	-0.012	-0.016	8.5	12.8	17.0	39	13
0.67	-0.25	-0.25	-0.34	0.016	0.024	3.8	-0.008	-0.008	-0.011	5.9	8.9	11.9	49	10
0.96	-0.27	-0.27	-0.36	0.020	0.021	2.6	-0.006	-0.006	-0.008	4.2	6.3	8.4	59	8
1.36	-0.29	-0.29	-0.38	0.024	0.017	1.8	-0.004	-0.005	-0.006	2.9	4.4	5.9	71	7
1.94	-0.25	-0.24	-0.29	-0.028	0.015	1.3	-0.003	-0.003	-0.003	2.1	3.1	4.1	84	6

Distortion < 0.1% for all magnifications. Working Distance = 188 mm for all magnifications.

12X NIR Zoom Lens System

Navitar's 12X NIR Zoom lens system offers high resolution and unparalleled sensitivity for capturing microscopic images. We have specially coated the glass on our 12X Zoom lens systems to be optimized for imaging in the 700-1550nm (0.7-1.5 microns) wavelength range. Our 12X NIR lens system is easy to configure and set up. Simply find the field of view and working distance required just as you would with any of our other standard 12X lenses.

For a complete listing of available 12X NIR parts, please reference our website or contact your Navitar sales representative. Body tubes with detents and apertures or motorized are available by custom order.

Applications Where NIR Optics are Useful

- Wafer characterization.
- Laser beam profiling.
- Optical component measurement and analysis.
- Fiber alignment and inspection.
- Assembly and monitoring.

About Using NIR Lenses

The wavelength band just beyond the visible is known as Near Infrared (NIR). NIR is the electromagnetic band of wavelengths between 0.7-1.5 microns (700-1550nm). When light strikes a glass surface, a portion is bounced back, thereby reducing the strength of the transmitted image. Apply this behavior to a zoom lens with many glass surfaces, and the result is a severe reduction in image intensity. To counteract the loss, the lenses are coated with materials that minimize this effect.

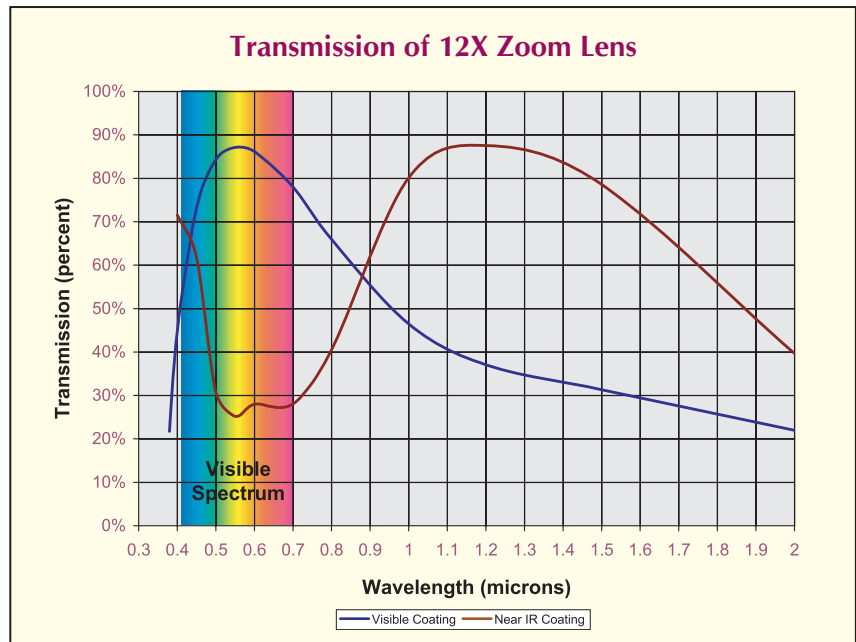

Note: Since NIR lenses are not operating within the visible spectrum, the resulting image is slightly different than when using a standard 12X system. The standard lens resolution limits of an NIR lens are based on an assumed average wavelength of 0.5 microns and is inversely proportional to wavelength (maximum MTF = $3000 \times \text{NA}$ in the visible wavelength). Therefore, substituting a wavelength of 1.5 microns will reduce the maximum resolution by a factor of 3. In practice, this means a slight reduction of contrast at the higher wavelengths.

Lens focal lengths shift slightly with wavelength, which impacts the Numerical Aperture (NA), which affects the depth of field ($.0005/\text{NA}^2$). Generally, the NA is reduced, which produces a greater depth of field, along with a reduction in maximum resolution. Standard NIR microscope objectives are usually lower in NA, also reducing maximum resolution values.



A list of all 12X NIR Zoom system components can be found on our website at www.machinevision.navitar.com.



12X Zoom Detented System

Navitar's Detented 12X Zoom provides twelve discrete detented positions in the zoom travel. Nominal positions at 1X, 1.5X, 2X, 2.5X, 3X, 3.5X, 4X, 4.5X, 5X, 6X, 6.5X and 7X on the zoom scale allow the end user to make an exact calibration repeatable within 0.05%. To order a detented zoom system, place a "D" after the standard part number.

Reticle Projector

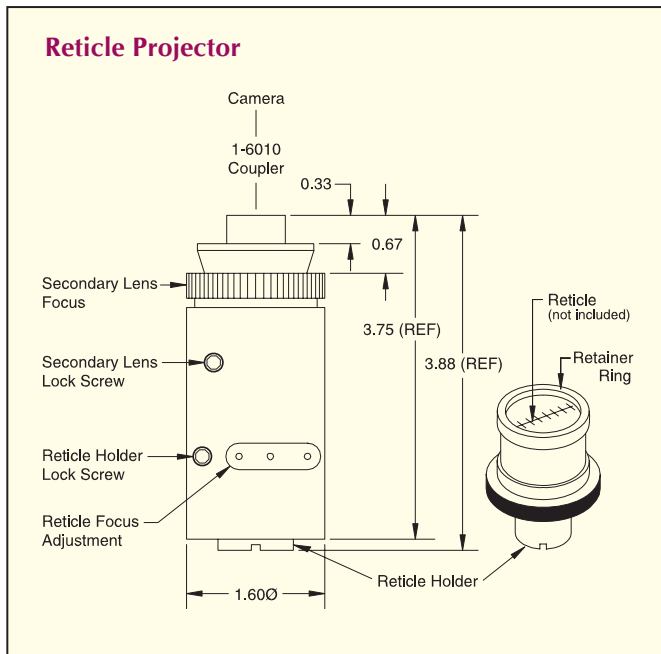

The Reticle Projector (1-60068) provides a means for superimposing a reticle (crosshair, micrometer scale, custom graphic) over the video image on the monitor. The information on the reticle must be contained to the size of the sensor. For example, if a 1/2" camera sensor is used, the reticle must have the information in a 4.8 x 6.4 mm area to be seen on the monitor. This reticle can then be used as a targeting device for measuring, machining, etc. (Reticles must be 21 mm in diameter and are sold separately.)

Advantages of Using a Reticle

- Enables quick identification of minute dimensions in small parts.
- Costs less than an electronic crosshair generator.
- The lines can be calibrated at various magnifications and assigned measuring values.
- Reticle pattern can be rotated on its center line to align with workpiece.

12X Zoom Accessories



-
-
-
-
-
-
-

Right Angle (RA) Accessories

The RA mount (1-6080) introduces a 90° bend in the optical axis, shortening the overall length of the system. The resulting image will be mirrored, thus erect and read backwards from right to left when viewed with a camera. The 12X Zoom system uses the RA adapters 1-60060 (.71X), 1-6118 (1X), 1-61997 (adjustable 1X RA), 1-6120 (2X) and 1-6187 (5X).



Non-Inverting Right Angle Accessories

The Non-Inverting RA mount (1-60165) introduces a 90° bend in the optical axis. The use of a penta prism results in an image that is erect and reads left to right. The 12X Zoom system utilizes the NIRA adapters 1-60172 (.67X), 1-60182 (1X Tele), 1-60175 (1X), and 1-60185 (2X), and 1-60188 (5X).



Object Side Right Angle Attachment

Navitar offers an object side right angle attachment (1-51490) that is added to the front of the 12X Zoom and can be used with all lens attachments except for the 1-50015.

-
-
-
-
-
-
-

Adapter Plates

Navitar offers a variety of different microscope converter plates so you can use your zoom system with Nikon, Olympus, Meiji, and Leica focus mounts (see diagram at right for part numbers).

Laser Injection Port

Navitar's Laser Injection Port (1-60380) provides a means of introducing a laser beam into the Zoom 6000 system. It is normally used between the end of the zoom lens and an infinity corrected objective so that the objective condenses the laser beam into a highly concentrated spot. A beamsplitter cube, rather than a plate, is used to minimize aberrations. The port is also useful for projecting targeting devices onto the object.

Auxiliary Viewing Port

The Auxiliary Viewing Port (1-60370) provides a second output port for an additional camera or for direct vision using an eyepiece. A 50/50 beam splitter cube is used for minimal image degradation. This assembly uses the RA Adapters (1-60060, 1-6118, 1-6120, 1-6187) to provide a parfocal image. Adapters are required in both vertical and horizontal viewing axis.

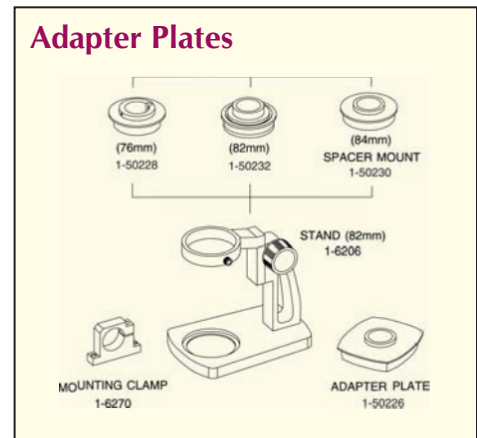

2X F-Mount Zoom Adapter

Navitar's 2X F-mount adapter (1-62922) is designed for larger format sensors (up to 30 mm diagonal). The adapter is configured as an F-mount, but its T-mount interface permits switching to other common flange formats. An RA version is available (1-63218).

Not recommended for use with the 12X Zoom System with sensors over 16 mm.



12X Zoom Field of View

Lens Attachment	Working Distance		2X F-Mount Zoom Adapter (Low-High)
0.25X 0.025 N.A. 1-50011	341	Mag	0.29X - 3.5X
		FOV	55 - 4.6*
0.5X 0.050 N.A. 1-50012	165	Mag	0.58X - 7.0X
		FOV	27.6 - 2.3*
0.75X 0.075 N.A. 1-50013	108	Mag	0.87X - 10.5X
		FOV	18.4 - 1.5*
NONE 0.10 N.A.	86	Mag	1.16X - 14.0X
		FOV	13.8 - 1.1*
1.5X 0.15 N.A. 1-50014	50	MAG	1.74X - 21.0X
		FOV	9.2 - 0.8*
2.0X 0.20 N.A. 1-51473	32	Mag	2.32X - 28.0X
		FOV	6.9 - 0.6*

*FOV for 16mm (max) sensor.

12X Zoom UltraZoom Field of View

Mitutoyo Objective Lens Long WD	Working Distance		2X F-Mount Zoom Adapter (Low-High)
5X 0.14 N.A.** 1-60226	34	Mag	2.8X - 33.0X
		FOV	5.7 - 0.48*
10X 0.28 N.A.** 1-60227	33	Mag	5.5X - 67.0X
		FOV	2.9 - 0.24*
20X 0.42 N.A.** 1-60228	20	MAG	11X - 133X
		FOV	1.5 - 0.12*
50X 0.55 N.A.** 1-60229	13	Mag	55X - 333X
		FOV	0.29 - 0.05*

*FOV for 16mm (max) sensor.

Low mag value is increased (total range reduced) and FOV adjusted accordingly if coaxial illumination is required.

**N.A. at full zoom. N.A. varies with zoom setting.



A complete listing of 12X Zoom accessories can be found on our web site at www.machinevision.navitar.com.

Accessories continued

Differential Interference Contrast (DIC) Modules

Two Differential Interference Contrast (DIC) modules are available from Navitar:

- the DIC Assembly Nikon-High Resolution module (1-63726) and
- the original DIC Assembly module (1-63102).

Both modules can be used on any ultra coax version (zoom or non-zoom) of the 12X Zoom.

DIC, when used with reflected light, can often be interpreted as a true three-dimensional representation of the surface geometry. It provides a clear distinction between raised and lowered regions in the specimen being viewed.

Using the DIC module in reflected light situations

Two polarizers, one in the illumination axis and one in the viewing axis, are crossed at 90 degrees such that when looking at a perfectly mirrored surface all light is extinguished by the second polarizer.

A prism, made from two pieces of quartz, is then placed between the illuminator beamsplitter and the objective. Due to the optical properties of the quartz, the polarized beam is split into two. The two beams, separated by a

minuscule amount, are polarized at 90 degrees to each other and one beam is shifted in relation to the other - a phase shift.

If the subject being viewed exhibits properties that change the length of the optical path of either beam (such as surface profiles, optical densities, etc.), both beams will experience further phase shifts.

With transverse movement of the prism the phase shifting performance of the prism may be accentuated and the final image is modified. By adding a polarization modifier, such as a 1/4 wave plate, after the illumination polarizer, the final effects are modified further.

The DIC modules work with object side NAs ranging from 0.05 to 0.50, with optimum performance in the range from 0.15 to 0.4. Lens attachments, operating in the above range will serve for macro applications. Any infinity corrected objectives designed for incident light will suffice for micro applications. Operating parameters, such as magnification and FOV, will be the same as Navitar's existing tables for the 12X Zoom system being used.

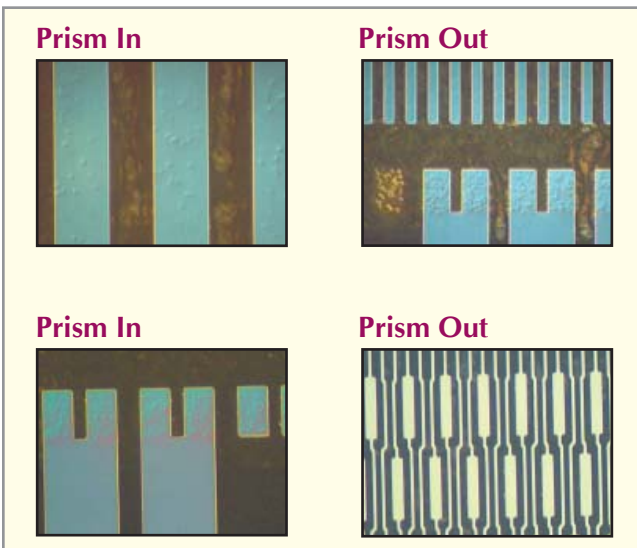

3D topography of a flat panel display circuit highlighted by employing differential interference contrast (DIC) and the 12x Zoom.



DIC Module System Diagram

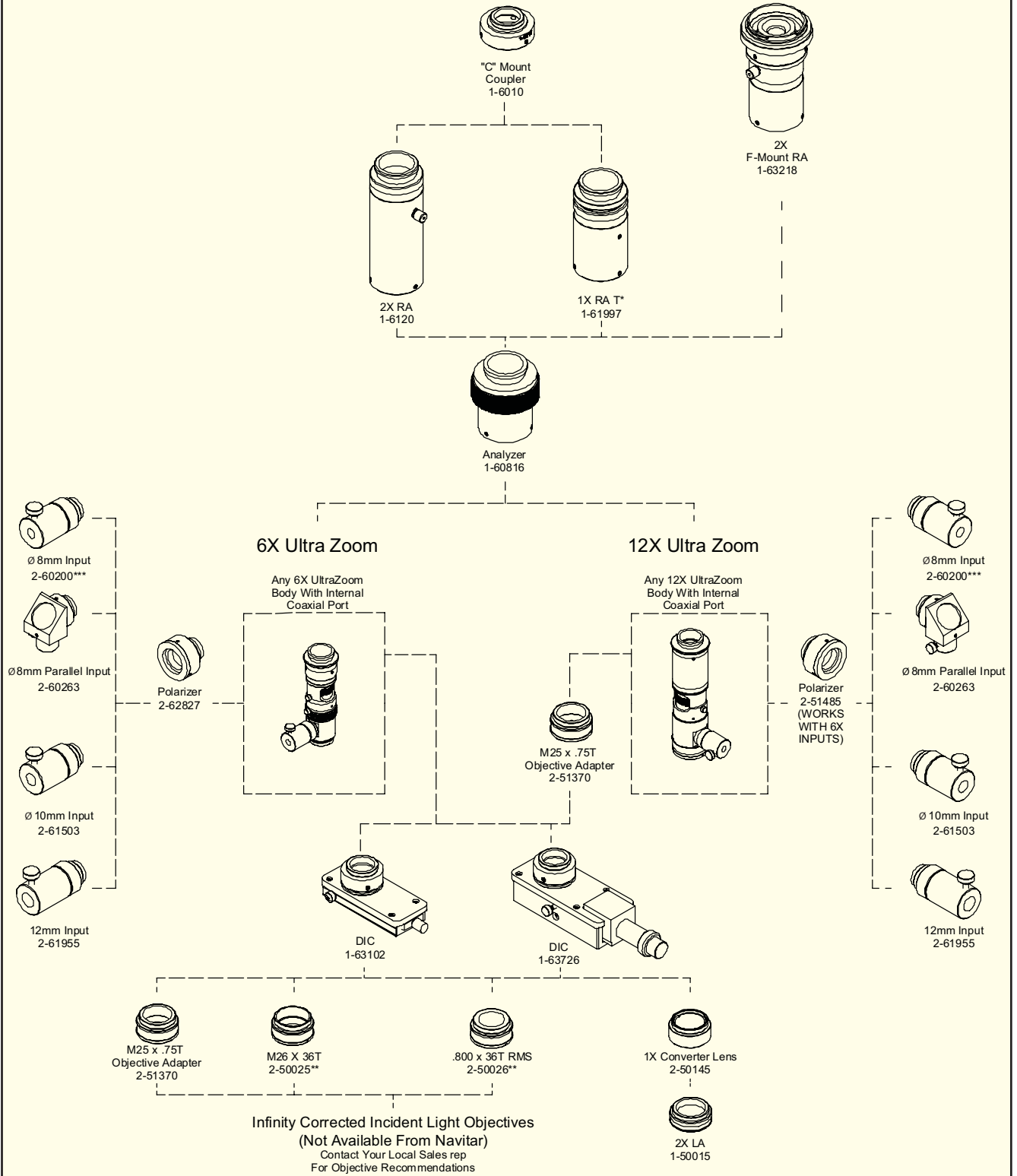

*T = Tele

** Included With 12X UltraZooms

*** Included With Manual 6000 UltraZooms

Accessories continued

Polarizers

Polarization is a contrast enhancement technique that can reduce back reflections and bring out salient features not readily visible with normal viewing.

If you choose to add a polarization option to your lens system, it requires an illumination polarizer (2-51485), an analyzer above the zoom, a quarter wave plate (optional), and a shorter version of an Adapter (RA) because the analyzer shortens the optical path by 50.8 mm.



Analyzer

When used in conjunction with a polarized light source, an analyzer (1-60816) allows for cross polarization of the light in the imaging system. This reduces reflections that can deteriorate the image quality. The analyzer must be used in conjunction with the right angle adapters.



Infinity Corrected Objectives

Infinity Corrected Objectives can be attached to the Zoom 6000 UltraZoom to increase the system magnification and decrease working distance. Navitar offers Mitutoyo long working distance objective lenses in magnifications of 5X, 10X, 20X, 50X (1-60226, 1-60227, 1-60228 and 1-60229) and Motic long working distance objective lenses in magnifications of 5X, 10X and 20X (1-62828, 1-62829, 1-62830).



Aperture Control

Lens systems can be designed with an internal iris that can be manipulated without cutting into the field of view. The iris permits the reduction of image intensity at the image plane, which reduces “blooming” and other damaging artifacts. The iris can also be closed down to essentially “stop down” the lens to reduce the Numerical Aperture of the lens. This narrowing of the light gathering cone produces a significant increase in the depth of field (the thickness of the envelope at the object, where various object heights are still in reasonable focus).

To have an aperture control feature designed into your system place an “A” after the standard part number.

Digital Camera Adapter

Couple Your Digital Camera or Camcorder to any C-mount or Standard SLR Lens, Microscope or Telescope

Navitar's unique Digital Camera Adapter allows you to couple your digital camera or camcorder to any C-mount or standard SLR lens, microscope or telescope, permitting a digital recording of your subject matter.

The Digital Camera Adapter comes with a male M37 x 0.75 thread, a popular thread size used on a number of different cameras. If, however, your camera does not have the correct thread size, the required adapter is readily available from most aftermarket camera shops (recommended web sites are www.dcpdirect.com or www.steves-digicams.com).

- Attaches digital camera or camcorder to any C-mount or standard SLR lens.
- Permits digital recording of subject matter.
- Includes a male M37 x 0.75 thread.
- Fits any standard 30 mm microscope eyepiece port.
- Enables any lens to be used as a standard monocular for direct viewing with the eye.

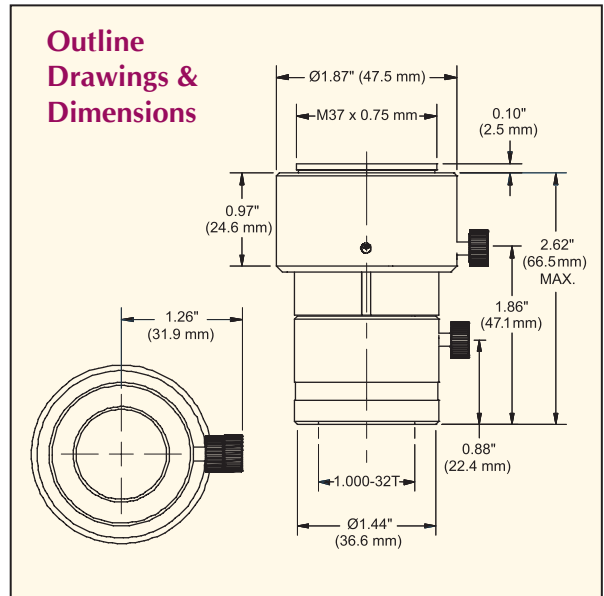

Accessories continued

Zoom Xtender

The Navitar Zoom Xtender (1-51560), with its 150 mm to infinity working distance, expands the versatility of your zoom system. It may be added to the Navitar 12X Zoom system extending your reach by a meter, two meters, and further. The Xtender allows you to maintain your internal focus and parfocal zooming, as well as keep your computer controlled motorization and detents.

The Xtender is designed to offer working distances beyond that achievable with standard Navitar attachments.

12X Zoom Typical Values (all dimensions in mm)

Working Distance	400	1000	2000
Mag. (min)	0.07	0.03	0.02
Mag. (max)	0.79	0.35	0.18
FOV (min)	8	18	35
FOV (max)	94	211	408
N.A. (min)	0.004	0.002	0.001
N.A. (max)	0.022	0.009	0.004
DOF (min)	1.0	6.5	26
DOF (max)	26	164	654

*12X Zoom with 12 mm fine focus
Sensor Length - 6.4mm, 1x adapter.*

Field of View Calculator Available Online

On the Navitar web site you will find an interactive Field of View Calculator. To use this calculator simply follow these easy steps:

1. Insert the applicable sensor dimension and the desired working distance in either or both zoom style columns.
2. Enter the extremes of zoom scale setting to determine the range of resulting performance. Note: The data presented assumes the use of a 1X adapter. The magnification may be increased with the use of a 2X adapter, with a resulting decrease in field of view and light level.
3. Pick the desired zoom system.
4. Choose a working distance range.
5. Read the required equipment to produce the final system.

Product Installation

In any system, working distance is modified by varying the separation of the applicable lens attachments. In the initial setup, adjust the zoom's fine focus to mid range of travel. Loosen the locking thumb screw on the Xtender and slide it between extremes of motion. Usually, the greater the separation of the lens attachments, the longer the working distance. If necessary, adjust the position of the zoom's fine focus to further modify this distance.

